

Sensitive SCRs

(0.8 A to 10 A)

General Description

The Teccor line of sensitive SCR semiconductors are half-wave unidirectional, gate-controlled rectifiers (SCR-thyristor) which complement Teccor's line of power SCRs. This group of packages offers ratings of 0.8 A to 10 A, and 200 V to 600 V with gate sensitivities of 12 μ A to 500 μ A. For gate currents in the 10 mA to 50 mA ranges, see "SCRs" section of this catalog.

The TO-220 and TO-92 are electrically isolated where the case or tab is internally isolated to allow the use of low-cost assembly and convenient packaging techniques.

Teccor's line of SCRs features glass-passivated junctions to ensure long-term device reliability and parameter stability. Teccor's glass offers a rugged, reliable barrier against junction contamination.

Tape-and-reel packaging is available for the TO-92 package. Consult the factory for more information.





Variations of devices covered in this data sheet are available for custom design applications. Consult the factory for more information.

Features

- Electrically-isolated TO-220 package
- High voltage capability — up to 600 V
- High surge capability — up to 100 A
- Glass-passivated chip

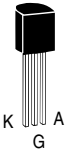
Compak Features

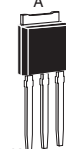
- Surface mount package — 0.8 A series
- New small-profile three-leaded Compak package
- Four gate sensitivities available
- Packaged in embossed carrier tape with 2,500 devices per reel
- Can replace SOT-223

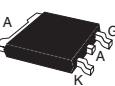
| TYPE | Part Number | | | | | I_T | | $V_{DRM} & V_{RRM}$ | I_{GT} | $I_{DRM} & I_{RRM}$ | | | V_{TM} |
|-------|---|---|---|---|---|--------------|-------------|---------------------|------------|-----------------------------|------------------------------|------------------------------|----------|
| | Non-isolated | | | | | (1) | | | | (2) (12) (14) (18) | (20) (21) | | |
| |  |  |  |  |  | Amps | | Volts | μ Amps | μ Amps | | | Volts |
| | See "Package Dimensions" section for variations. (11) | | | | | $I_{T(RMS)}$ | $I_{T(AV)}$ | MIN | MAX | T_C or $T_L = 25^\circ C$ | T_C or $T_L = 100^\circ C$ | T_C or $T_L = 110^\circ C$ | MAX |
| 0.8 A | | | | S2S1 | 0.8 | 0.51 | 200 | 12 | 2 | | 100 | 1.7 | |
| | | | | S4S1 | 0.8 | 0.51 | 400 | 12 | 2 | | 100 | 1.7 | |
| | | | | S6S1 | 0.8 | 0.51 | 600 | 12 | 2 | | 100 | 1.7 | |
| | | | | S2S2 | 0.8 | 0.51 | 200 | 50 | 2 | | 100 | 1.7 | |
| | | | | S4S2 | 0.8 | 0.51 | 400 | 50 | 2 | | 100 | 1.7 | |
| | | | | S6S2 | 0.8 | 0.51 | 600 | 50 | 2 | | 100 | 1.7 | |
| | | | | S2S | 0.8 | 0.51 | 200 | 200 | 2 | | 100 | 1.7 | |
| | | | | S4S | 0.8 | 0.51 | 400 | 200 | 2 | | 100 | 1.7 | |
| | | | | S6S | 0.8 | 0.51 | 600 | 200 | 2 | | 100 | 1.7 | |
| | | | | S2S3 | 0.8 | 0.51 | 200 | 500 | 2 | | 100 | 1.7 | |
| | | | | S4S3 | 0.8 | 0.51 | 400 | 500 | 2 | | 100 | 1.7 | |
| | | | | S6S3 | 0.8 | 0.51 | 600 | 500 | 2 | | 100 | 1.7 | |
| | | EC103B | | | 0.8 | 0.51 | 200 | 200 | 1 | 50 | | 1.7 | |
| | | EC103D | | | 0.8 | 0.51 | 400 | 200 | 1 | 50 | | 1.7 | |
| | | EC103M | | | 0.8 | 0.51 | 600 | 200 | 2 | 100 | | 1.7 | |
| | | EC103B1 | | | 0.8 | 0.51 | 200 | 12 | 1 | 50 | | 1.7 | |
| | | EC103D1 | | | 0.8 | 0.51 | 400 | 12 | 1 | 50 | | 1.7 | |
| | | EC103M1 | | | 0.8 | 0.51 | 600 | 12 | 2 | 100 | | 1.7 | |
| | | EC103B2 | | | 0.8 | 0.51 | 200 | 50 | 1 | 50 | | 1.7 | |
| | | EC103D2 | | | 0.8 | 0.51 | 400 | 50 | 1 | 50 | | 1.7 | |
| | EC103M2 | | | 0.8 | 0.51 | 600 | 50 | 2 | 100 | | 1.7 | | |
| | EC103B3 | | | 0.8 | 0.51 | 200 | 500 | 1 | 50 | | 1.7 | | |
| | EC103D3 | | | 0.8 | 0.51 | 400 | 500 | 1 | 50 | | 1.7 | | |
| | EC103M3 | | | 0.8 | 0.51 | 600 | 500 | 2 | 100 | | 1.7 | | |
| | 2N5064 | | | 0.8 | 0.51 | 200 | 200 | 1 | | 50 | 1.7 | | |
| | 2N6565 | | | 0.8 | 0.51 | 400 | 200 | 1 | | 100 | 1.7 | | |
| 1.5 A | | | | TCR22-4 | 1.5 | 0.95 | 200 | 200 | 1 | | 100 | 1.5 | |
| | | | | TCR22-6 | 1.5 | 0.95 | 400 | 200 | 1 | | 100 | 1.5 | |
| | | | | TCR22-8 | 1.5 | 0.95 | 600 | 200 | 2 | | 100 | 1.5 | |
| 4 A | | T106B1 | | | 4 | 2.5 | 200 | 200 | 2 | | 100 | 2.2 | |
| | | T106D1 | | | 4 | 2.5 | 400 | 200 | 2 | | 100 | 2.2 | |
| | | T106M1 | | | 4 | 2.5 | 600 | 200 | 2 | | 100 | 2.2 | |
| | | T107B1 | | | 4 | 2.5 | 200 | 500 | 2 | | 100 | 2.5 | |
| | | T107D1 | | | 4 | 2.5 | 400 | 500 | 2 | | 100 | 2.5 | |
| | | T107M1 | | | 4 | 2.5 | 600 | 500 | 2 | | 100 | 2.5 | |
| | | | S2004VS1 | S2004DS1 | 4 | 2.5 | 200 | 50 | 2 | | 100 | 1.6 | |
| | | | S4004VS1 | S4004DS1 | 4 | 2.5 | 400 | 50 | 2 | | 100 | 1.6 | |
| | | | S6004VS1 | S6004DS1 | 4 | 2.5 | 600 | 50 | 2 | | 100 | 1.6 | |
| | | | S2004VS2 | S2004DS2 | 4 | 2.5 | 200 | 200 | 2 | | 100 | 1.6 | |
| | | S4004VS2 | S4004DS2 | 4 | 2.5 | 400 | 200 | 2 | | 100 | 1.6 | | |
| | | S6004VS2 | S6004DS2 | 4 | 2.5 | 600 | 200 | 2 | | 100 | 1.6 | | |

See "General Notes" on page E5 - 4 and "Electrical Specifications Notes" on page E5 - 5

| V _{GT} | | | I _H | I _{GM} | V _{GRM} | P _{GM} | P _{G(AV)} | I _{TSM} | dv/dt | | di/dt | t _{gt} | t _q | I ² t |
|--|---|--|-----------------------|-----------------|------------------|-----------------|--------------------|------------------|-------|------------|-----------|-----------------|----------------|------------------------|
| (4) (12) (22) | | | (5) (15) (16) (19) | (17) | | (17) | | (6) (7) (13) | | | | (8) | (9) | |
| Volts | | | | | | | | Amps | | | | | | |
| T _C or T _L = -40 °C | T _C or T _L = 25 °C | T _C or T _L = 110 °C | mAmps | Amps | Volts | Watts | Watts | 60/50 Hz | | Volts/μSec | Amps/μSec | μSec | μSec | Amps ² /Sec |
| MAX | | | MAX | | MIN | | | | MIN | TYP (23) | | TYP | MAX | |
| 1.2 | 0.8 | 0.2 | 5 | 1 | 5 | 1 | 0.1 | 20/16 | 20 | | 50 | 2 | 60 | 1.6 |
| 1.2 | 0.8 | 0.2 | 5 | 1 | 5 | 1 | 0.1 | 20/16 | 20 | | 50 | 2 | 60 | 1.6 |
| 1.2 | 0.8 | 0.2 | 5 | 1 | 5 | 1 | 0.1 | 20/16 | 10 | | 50 | 2 | 60 | 1.6 |
| 1.2 | 0.8 | 0.25 | 5 | 1 | 5 | 1 | 0.1 | 20/16 | 25 | | 50 | 3 | 60 | 1.6 |
| 1.2 | 0.8 | 0.25 | 5 | 1 | 5 | 1 | 0.1 | 20/16 | 25 | | 50 | 3 | 60 | 1.6 |
| 1.2 | 0.8 | 0.25 | 5 | 1 | 5 | 1 | 0.1 | 20/16 | 10 | | 50 | 3 | 60 | 1.6 |
| 1.2 | 0.8 | 0.25 | 5 | 1 | 5 | 1 | 0.1 | 20/16 | 30 | | 50 | 4 | 50 | 1.6 |
| 1.2 | 0.8 | 0.25 | 5 | 1 | 5 | 1 | 0.1 | 20/16 | 30 | | 50 | 4 | 50 | 1.6 |
| 1.2 | 0.8 | 0.25 | 5 | 1 | 5 | 1 | 0.1 | 20/16 | 15 | | 50 | 4 | 50 | 1.6 |
| 1.2 | 0.8 | 0.25 | 8 | 1 | 5 | 1 | 0.1 | 20/16 | 40 | | 50 | 5 | 45 | 1.6 |
| 1.2 | 0.8 | 0.25 | 8 | 1 | 5 | 1 | 0.1 | 20/16 | 40 | | 50 | 5 | 45 | 1.6 |
| 1.2 | 0.8 | 0.25 | 8 | 1 | 5 | 1 | 0.1 | 20/16 | 20 | | 50 | 5 | 45 | 1.6 |
| 1.2 | 0.8 | 0.25 | 5 | 1 | 5 | 1 | 0.1 | 20/16 | 30 | | 50 | 3.5 | 50 | 1.6 |
| 1.2 | 0.8 | 0.25 | 5 | 1 | 5 | 1 | 0.1 | 20/16 | 30 | | 50 | 3.5 | 50 | 1.6 |
| 1.2 | 0.8 | 0.25 | 5 | 1 | 5 | 1 | 0.1 | 20/16 | 15 | | 50 | 3.5 | 50 | 1.6 |
| 1.2 | 0.8 | 0.2 | 5 | 1 | 5 | 1 | 0.1 | 20/16 | 20 | | 50 | 2 | 60 | 1.6 |
| 1.2 | 0.8 | 0.2 | 5 | 1 | 5 | 1 | 0.1 | 20/16 | 20 | | 50 | 2 | 60 | 1.6 |
| 1.2 | 0.8 | 0.2 | 5 | 1 | 5 | 1 | 0.1 | 20/16 | 10 | | 50 | 2 | 60 | 1.6 |
| 1.2 | 0.8 | 0.25 | 5 | 1 | 5 | 1 | 0.1 | 20/16 | 25 | | 50 | 3 | 60 | 1.6 |
| 1.2 | 0.8 | 0.25 | 5 | 1 | 5 | 1 | 0.1 | 20/16 | 25 | | 50 | 3 | 60 | 1.6 |
| 1.2 | 0.8 | 0.25 | 5 | 1 | 5 | 1 | 0.1 | 20/16 | 10 | | 50 | 3 | 60 | 1.6 |
| 1.2 | 0.8 | 0.25 | 8 | 1 | 5 | 1 | 0.1 | 20/16 | 40 | | 50 | 5 | 45 | 1.6 |
| 1.2 | 0.8 | 0.25 | 8 | 1 | 5 | 1 | 0.1 | 20/16 | 40 | | 50 | 5 | 45 | 1.6 |
| 1.2 | 0.8 | 0.25 | 8 | 1 | 5 | 1 | 0.1 | 20/16 | 20 | | 50 | 5 | 45 | 1.6 |
| 1.2 | 0.8 | 0.25 | 5 | 1 | 5 | 1 | 0.1 | 20/16 | 25 | | 50 | 2.2 | 60 | 1.6 |
| 1.2 | 0.8 | 0.25 | 5 | 1 | 6 | 1 | 0.1 | 20/16 | 25 | | 50 | 2.2 | 60 | 1.6 |
| 1 | 0.8 | 0.25 | 5 | 1 | 6 | 1 | 0.1 | 20/16 | 60 | | 50 | 3.5 | 50 | 1.6 |
| 1 | 0.8 | 0.25 | 5 | 1 | 6 | 1 | 0.1 | 20/16 | 40 | | 50 | 3.5 | 50 | 1.6 |
| 1 | 0.8 | 0.25 | 5 | 1 | 6 | 1 | 0.1 | 20/16 | 30 | | 50 | 3.5 | 50 | 1.6 |
| 1 | 0.8 | 0.2 | 5 | 1 | 6 | 1 | 0.1 | 20/16 | | 8 | 50 | 4 | 50 | 1.6 |
| 1 | 0.8 | 0.2 | 5 | 1 | 6 | 1 | 0.1 | 20/16 | | 8 | 50 | 4 | 50 | 1.6 |
| 1 | 0.8 | 0.2 | 5 | 1 | 6 | 1 | 0.1 | 20/16 | | 8 | 50 | 4 | 50 | 1.6 |
| 1 | 0.8 | 0.2 | 6 | 1 | 6 | 1 | 0.1 | 20/16 | | 8 | 50 | 5 | 45 | 1.6 |
| 1 | 0.8 | 0.2 | 6 | 1 | 6 | 1 | 0.1 | 20/16 | | 8 | 50 | 5 | 45 | 1.6 |
| 1 | 0.8 | 0.2 | 6 | 1 | 6 | 1 | 0.1 | 20/16 | | 8 | 50 | 5 | 45 | 1.6 |
| 1 | 0.8 | 0.2 | 4 | 1 | 6 | 1 | 0.1 | 30/25 | | 8 | 50 | 3 | 50 | 3.7 |
| 1 | 0.8 | 0.2 | 4 | 1 | 6 | 1 | 0.1 | 30/25 | | 8 | 50 | 3 | 50 | 3.7 |
| 1 | 0.8 | 0.2 | 4 | 1 | 6 | 1 | 0.1 | 30/25 | | 8 | 50 | 3 | 50 | 3.7 |
| 1 | 0.8 | 0.2 | 6 | 1 | 6 | 1 | 0.1 | 30/25 | | 8 | 50 | 4 | 50 | 3.7 |
| 1 | 0.8 | 0.2 | 6 | 1 | 6 | 1 | 0.1 | 30/25 | | 8 | 50 | 4 | 50 | 3.7 |
| 1 | 0.8 | 0.2 | 6 | 1 | 6 | 1 | 0.1 | 30/25 | | 8 | 50 | 4 | 50 | 3.7 |

See "General Notes" on page E5 - 4 and "Electrical Specifications Notes" on page E5 - 5

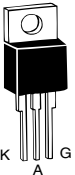
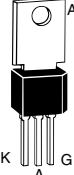
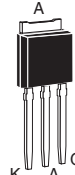
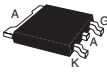
| TYPE | Part Number | | | | I _T | | V _{DRM} & V _{RRM} | I _{GT} | I _{DRM} & I _{RRM} | | V _{TM} |
|---|---|---|---|---|--------------------|-------|-------------------------------------|------------------------|-------------------------------------|----------|-----------------|
| | Isolated | Non-isolated | | | | | | | | | |
| |  |  |  |  | (1) | | (2) (12) | (20) (21) | | (3) (10) | |
| | TO-220 | TO-202 | TO-251 V-Pak | TO-252 D-Pak | Amps | | | μAmps | | | |
| See "Package Dimensions" section for variations. (11) | | | | I _{T(RMS)} | I _{T(AV)} | Volts | μAmps | T _C = 25 °C | T _C = 110 °C | Volts | |
| | | | | MAX | MAX | MIN | MAX | MAX | MAX | MAX | |
| 6 A | S2006LS2 | S2006FS21 | S2006VS2 | S2006DS2 | 6 | 3.8 | 200 | 200 | 5 | 250 | 1.6 |
| | S4006LS2 | S4006FS21 | S4006VS2 | S4006DS2 | 6 | 3.8 | 400 | 200 | 5 | 250 | 1.6 |
| | S6006LS2 | S6006FS21 | S6006VS2 | S6006DS2 | 6 | 3.8 | 600 | 200 | 5 | 250 | 1.6 |
| | S2006LS3 | S2006FS31 | S2006VS3 | S2006DS3 | 6 | 3.8 | 200 | 500 | 5 | 250 | 1.6 |
| | S4006LS3 | S4006FS31 | S4006VS3 | S4006DS3 | 6 | 3.8 | 400 | 500 | 5 | 250 | 1.6 |
| | S6006LS3 | S6006FS31 | S6006VS3 | S6006DS3 | 6 | 3.8 | 600 | 500 | 5 | 250 | 1.6 |
| 8 A | S2008LS2 | S2008FS21 | S2008VS2 | S2008DS2 | 8 | 5.1 | 200 | 200 | 5 | 250 | 1.6 |
| | S4008LS2 | S4008FS21 | S4008VS2 | S4008DS2 | 8 | 5.1 | 400 | 200 | 5 | 250 | 1.6 |
| | S6008LS2 | S6008FS21 | S6008VS2 | S6008DS2 | 8 | 5.1 | 600 | 200 | 5 | 250 | 1.6 |
| | S2008LS3 | S2008FS31 | S2008VS3 | S2008DS3 | 8 | 5.1 | 200 | 500 | 5 | 250 | 1.6 |
| | S4008LS3 | S4008FS31 | S4008VS3 | S4008DS3 | 8 | 5.1 | 400 | 500 | 5 | 250 | 1.6 |
| | S6008LS3 | S6008FS31 | S6008VS3 | S6008DS3 | 8 | 5.1 | 600 | 500 | 5 | 250 | 1.6 |
| 10 A | S2010LS2 | S2010FS21 | S2010VS2 | S2010DS2 | 10 | 6.4 | 200 | 200 | 5 | 250 | 1.6 |
| | S4010LS2 | S4010FS21 | S4010VS2 | S4010DS2 | 10 | 6.4 | 400 | 200 | 5 | 250 | 1.6 |
| | S6010LS2 | S6010FS21 | S6010VS2 | S6010DS2 | 10 | 6.4 | 600 | 200 | 5 | 250 | 1.6 |
| | S2010LS3 | S2010FS31 | S2010VS3 | S2010DS3 | 10 | 6.4 | 200 | 500 | 5 | 250 | 1.6 |
| | S4010LS3 | S4010FS31 | S4010VS3 | S4010DS3 | 10 | 6.4 | 400 | 500 | 5 | 250 | 1.6 |
| | S6010LS3 | S6010FS31 | S6010VS3 | S6010DS3 | 10 | 6.4 | 600 | 500 | 5 | 250 | 1.6 |

Specific Test Conditions

- di/dt** — Maximum rate-of-change of on-state current; I_{GT} = 50 mA pulse width ≥15 μsec with ≤0.1 μs rise time
- dv/dt** — Critical rate-of-rise of forward off-state voltage
- I²t** — RMS surge (non-repetitive) on-state current for period of 8.3 ms for fusing
- I_{DRM} and I_{RRM}** — Peak off-state current at V_{DRM} and V_{RRM}
- I_{GT}** — DC gate trigger current V_D = 6 V dc; R_L = 100 Ω
- I_{GM}** — Peak gate current
- I_H** — DC holding current; initial on-state current = 20 mA
- I_T** — Maximum on-state current
- I_{TSM}** — Peak one-cycle forward surge current
- P_{G(AV)}** — Average gate power dissipation
- P_{GM}** — Peak gate power dissipation
- t_{gt}** — Gate controlled turn-on time gate pulse = 10 mA; minimum width = 15 μS with rise time ≤0.1 μs
- t_q** — Circuit commutated turn-off time
- V_{DRM} and V_{RRM}** — Repetitive peak off-state forward and reverse voltage
- V_{GRM}** — Peak reverse gate voltage
- V_{GT}** — DC gate trigger voltage; V_D = 6 V dc; R_L = 100 Ω
- V_{TM}** — Peak on-state voltage





General Notes

- Teccor 2N5064 and 2N6565 Series devices conform to all JEDEC registered data. See specifications table on pages E5 - 2 and E5 - 3.
- The case lead temperature (T_C or T_L) is measured as shown on dimensional outline drawings in the "Package Dimensions" section of this catalog.
- All measurements (except I_{GT}) are made with an external resistor R_{GK} = 1 kΩ unless otherwise noted.
- All measurements are made at 60 Hz with a resistive load at an ambient temperature of +25 °C unless otherwise specified.
- Operating temperature (T_J) is -65 °C to +110 °C for EC Series devices, -65 °C to +125 °C for 2N Series devices, -40 °C to +125 °C for "TCR" Series, and -40 °C to +110 °C for all others.
- Storage temperature range (T_S) is -65 °C to +150 °C for TO-92 devices, -40 °C to +150 °C for TO-202 and Compak devices, and -40 °C to +125 °C for all others.
- Lead solder temperature is a maximum of +230 °C for 10 seconds maximum ≥1/16" (1.59 mm) from case.

| V_{GT} | | | I_H | I_{GM} | V_{GRM} | P_{GM} | $P_{G(AV)}$ | I_{TSM} | dv/dt | di/dt | t_{gt} | t_q | I^2t |
|---------------------|--------------------|---------------------|----------|----------|-----------|----------|-------------|-----------|---------------------|-----------------|-----------|-----------|-----------------------|
| (4) (12) (22) | | | (5) (19) | (17) | | (17) | | (6) (13) | | | (8) | (9) | |
| Volts | | | | | | | | | Volts/ μ Sec | | | | |
| $T_C = -40^\circ C$ | $T_C = 25^\circ C$ | $T_C = 110^\circ C$ | mAmps | Amps | Volts | Watts | Watts | Amps | $T_C = 110^\circ C$ | Amps/ μ Sec | μ Sec | μ Sec | Amps ² Sec |
| MAX | | | MAX | | MIN | | | 60/50 Hz | TYP | | TYP | MAX | |
| 1 | 0.8 | 0.25 | 6 | 1 | 6 | 1 | 0.1 | 100/83 | 10 | 100 | 4 | 50 | 41 |
| 1 | 0.8 | 0.25 | 6 | 1 | 6 | 1 | 0.1 | 100/83 | 8 | 100 | 4 | 50 | 41 |
| 1 | 0.8 | 0.25 | 6 | 1 | 6 | 1 | 0.1 | 100/83 | 8 | 100 | 4 | 50 | 41 |
| 1 | 0.8 | 0.25 | 8 | 1 | 6 | 1 | 0.1 | 100/83 | 10 | 100 | 5 | 45 | 41 |
| 1 | 0.8 | 0.25 | 8 | 1 | 6 | 1 | 0.1 | 100/83 | 8 | 100 | 5 | 45 | 41 |
| 1 | 0.8 | 0.25 | 8 | 1 | 6 | 1 | 0.1 | 100/83 | 8 | 100 | 5 | 45 | 41 |
| 1 | 0.8 | 0.25 | 6 | 1 | 6 | 1 | 0.1 | 100/83 | 10 | 100 | 4 | 50 | 41 |
| 1 | 0.8 | 0.25 | 6 | 1 | 6 | 1 | 0.1 | 100/83 | 8 | 100 | 4 | 50 | 41 |
| 1 | 0.8 | 0.25 | 6 | 1 | 6 | 1 | 0.1 | 100/83 | 8 | 100 | 4 | 50 | 41 |
| 1 | 0.8 | 0.25 | 8 | 1 | 6 | 1 | 0.1 | 100/83 | 10 | 100 | 5 | 45 | 41 |
| 1 | 0.8 | 0.25 | 8 | 1 | 6 | 1 | 0.1 | 100/83 | 8 | 100 | 5 | 45 | 41 |
| 1 | 0.8 | 0.25 | 8 | 1 | 6 | 1 | 0.1 | 100/83 | 8 | 100 | 5 | 45 | 41 |
| 1 | 0.8 | 0.25 | 6 | 1 | 6 | 1 | 0.1 | 100/83 | 10 | 100 | 4 | 50 | 41 |
| 1 | 0.8 | 0.25 | 6 | 1 | 6 | 1 | 0.1 | 100/83 | 8 | 100 | 4 | 50 | 41 |
| 1 | 0.8 | 0.25 | 6 | 1 | 6 | 1 | 0.1 | 100/83 | 8 | 100 | 4 | 50 | 41 |
| 1 | 0.8 | 0.25 | 8 | 1 | 6 | 1 | 0.1 | 100/83 | 10 | 100 | 5 | 45 | 41 |
| 1 | 0.8 | 0.25 | 8 | 1 | 6 | 1 | 0.1 | 100/83 | 8 | 100 | 5 | 45 | 41 |
| 1 | 0.8 | 0.25 | 8 | 1 | 6 | 1 | 0.1 | 100/83 | 8 | 100 | 5 | 45 | 41 |

Electrical Specifications Notes

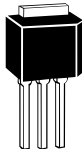
- (1) See Figure E5.1 through Figure E5.9 for current ratings at specified operating temperatures.
- (2) See Figure E5.10 for I_{GT} versus T_C or T_L .
- (3) See Figure E5.11 for instantaneous on-state current (I_T) versus on-state voltage (V_T) TYP.
- (4) See Figure E5.12 for V_{GT} versus T_C or T_L .
- (5) See Figure E5.13 for I_H versus T_C or T_L .
- (6) For more than one full cycle, see Figure E5.14.
- (7) 0.8 A to 4 A devices also have a pulse peak forward current on-state rating (repetitive) of 75 A. This rating applies for operation at 60 Hz, 75 °C maximum tab (or anode) lead temperature, switching from 80 V peak, sinusoidal current pulse width of 10 μ s minimum, 15 μ s maximum. See Figure E5.20 and Figure E5.21.
- (8) See Figure E5.15 for t_{gt} versus I_{GT} .
- (9) Test conditions as follows:
 - T_C or $T_L \leq 80^\circ C$, rectangular current waveform
 - Rate-of-rise of current ≤ 10 A/ μ s
 - Rate-of-reversal of current ≤ 5 A/ μ s
 - $I_{TM} = 1$ A (50 μ s pulse), Repetition Rate = 60 pps
 - $V_{RRM} = \text{Rated}$
 - $V_R = 15$ V minimum, $V_{DRM} = \text{Rated}$
 - Rate-of-rise reapplied forward blocking voltage = 5 V/ μ s
 - Gate Bias = 0 V, 100 Ω (during turn-off time interval)
- (10) Test condition is maximum rated RMS current except TO-92 devices are 1.2 A_{PK} ; T106/T107 devices are 4 A_{PK} .
- (11) See package outlines for lead form configurations. When ordering special lead forming, add type number as suffix to part number.
- (12) $V_D = 6$ V dc, $R_L = 100 \Omega$ (See Figure E5.19 for simple test circuit for measuring gate trigger voltage and gate trigger current.)
- (13) See Figure E5.1 through Figure E5.9 for maximum allowable case temperature at maximum rated current.
- (14) $I_{GT} = 500 \mu A$ maximum at $T_C = -40^\circ C$ for T106 devices
- (15) $I_H = 10$ mA maximum at $T_C = -65^\circ C$ for 2N5064 Series and 2N6565 Series devices
- (16) $I_H = 6$ mA maximum at $T_C = -40^\circ C$ for T106 devices
- (17) Pulse Width $\leq 10 \mu$ s
- (18) $I_{GT} = 350 \mu A$ maximum at $T_C = -65^\circ C$ for 2N5064 Series and 2N6565 Series devices
- (19) Latching current can be higher than 20 mA for higher I_{GT} types. Also, latching current can be much higher at $-40^\circ C$. See Figure E5.18.
- (20) T_C or $T_L = T_J$ for test conditions in off state
- (21) I_{DRM} and $I_{RRM} = 50 \mu A$ for 2N5064 and 100 μA for 2N6565 at 125 °C
- (22) TO-92 devices specified at $-65^\circ C$ instead of $-40^\circ C$
- (23) $T_C = 110^\circ C$

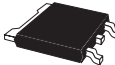
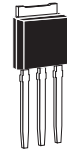
| Thermal Resistance (Steady State) $R_{\theta JC}$ [$R_{\theta JA}$] °C/W (TYPICAL) | | | | | | | |
|---|--|---|--|---|--|--|--|
| Package Code | E | L | F2 | F | C | D | V |
| Type |  TO-92 |  TO-220 |  TO-202 Type 2, 4, & 41 |  TO-202 Type 1 & 3 |  Compak |  TO-252 D-Pak |  TO-251 V-Pak |
| 0.8 A | 75 [160] | | | | 60* | | |
| 1.5 A | 50 [160] | | | | | | |
| 4.0 A | | | 10 [100] | 6.2 [80] | | 3.0 | 3.8 [85] |
| 6.0 A | | 4.0 [65] | | 4.3 | | 1.8 | 2.4 |
| 8.0 A | | 3.4 | | 3.9 | | 1.5 | 2.1 |
| 10.0 A | | 3.0 | | 3.4 | | 1.45 | 1.72 |

*Mounted on 1 cm² copper foil surface; two-ounce copper foil

Electrical Isolation

Teccor's isolated sensitive SCRs will withstand a minimum high potential test of 2500 V ac rms from leads to mounting tab over the device's operating temperature range. The following table shows other standard and optional isolation ratings.

| Electrical Isolation * from Leads to Mounting Tab | |
|--|-------------|
| V AC RMS | TO-220 |
| 2500 | Standard |
| 4000 | Optional ** |

*UL Recognized File #E71639

**For 4000 V isolation, use "V" suffix in part number.

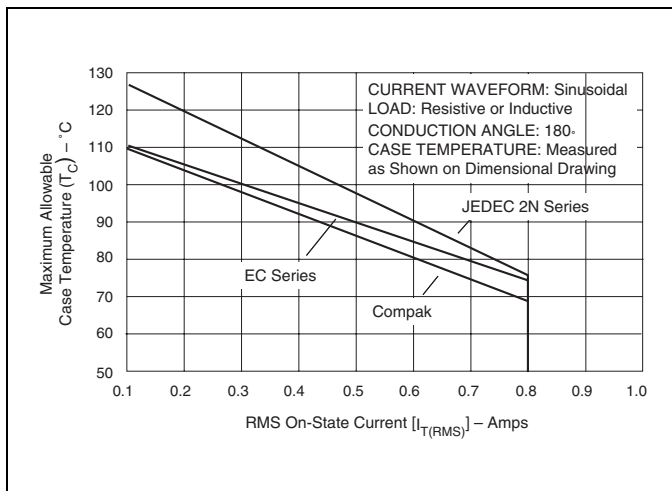

Figure E5.1 Maximum Allowable Case Temperature versus RMS On-state Current

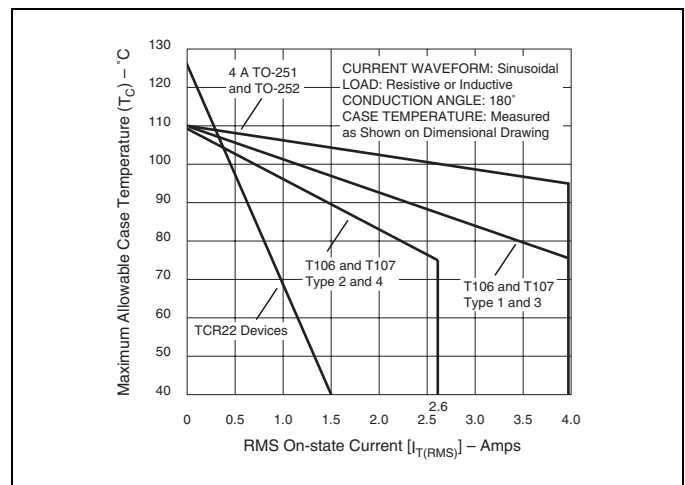

Figure E5.2 Maximum Allowable Case Temperature versus RMS On-state Current

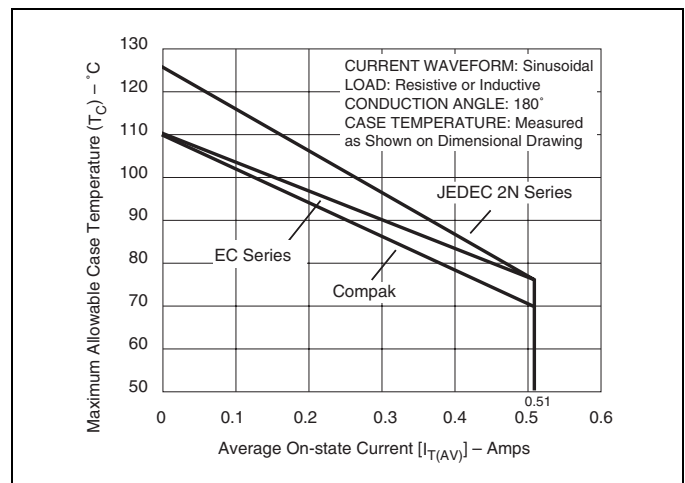

Figure E5.3 Maximum Allowable Case Temperature versus Average On-state Current

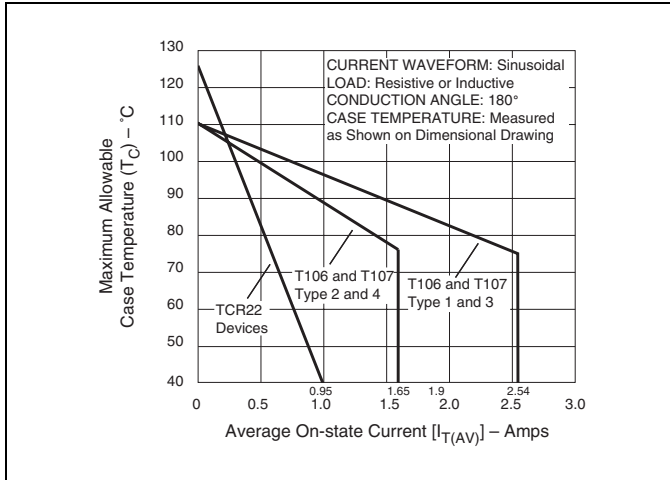

Figure E5.4 Maximum Allowable Case Temperature versus Average On-state Current

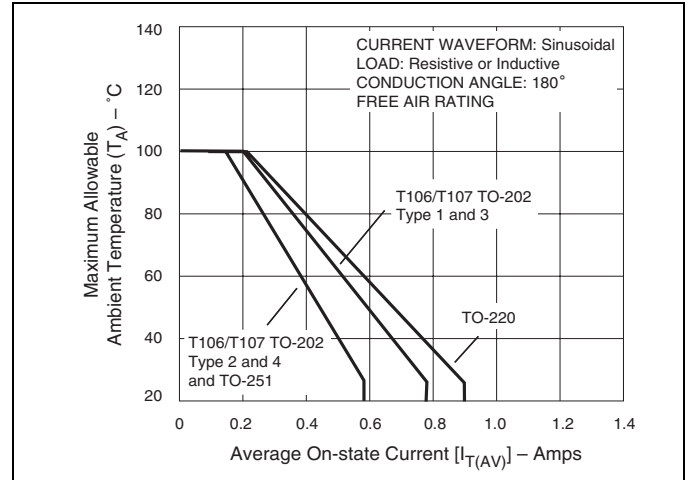

Figure E5.7 Maximum Allowable Ambient Temperature versus Average On-state Current

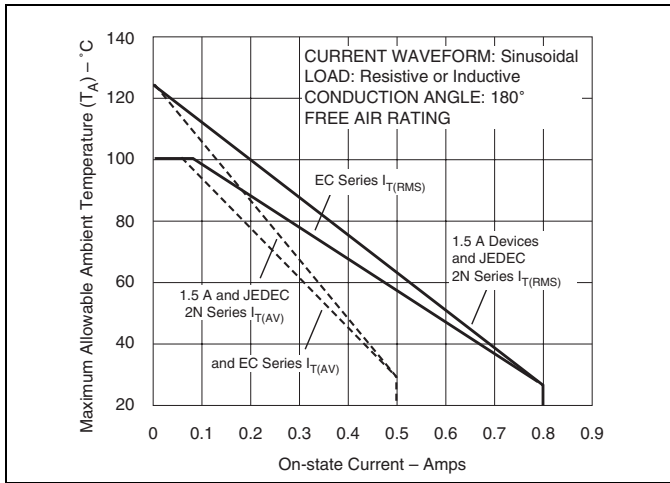

Figure E5.5 Maximum Allowable Ambient Temperature versus On-state Current

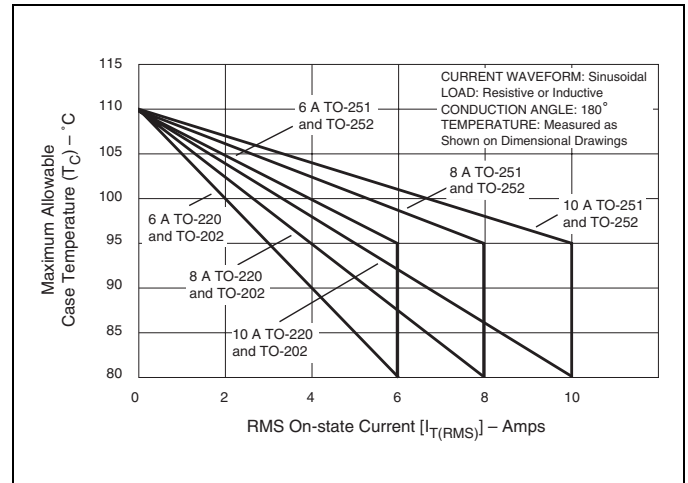

Figure E5.8 Maximum Allowable Case Temperature versus RMS On-state Current

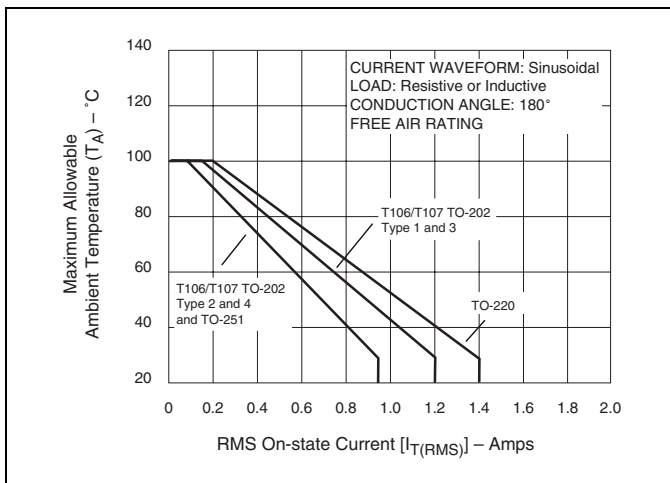

Figure E5.6 Maximum Allowable Ambient Temperature versus RMS On-state Current

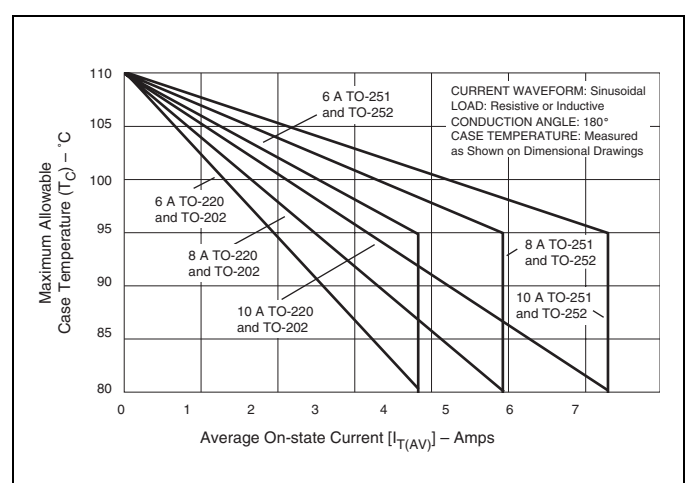

Figure E5.9 Maximum Allowable Case Temperature versus Average On-state Current

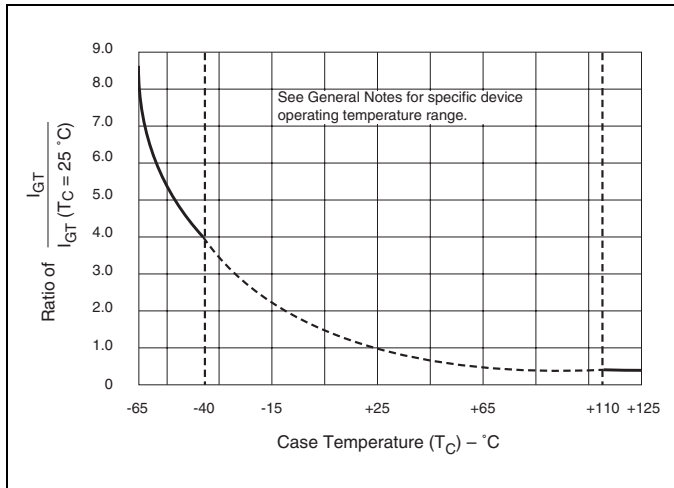

Figure E5.10 Normalized DC Gate-Trigger Current versus Case Temperature

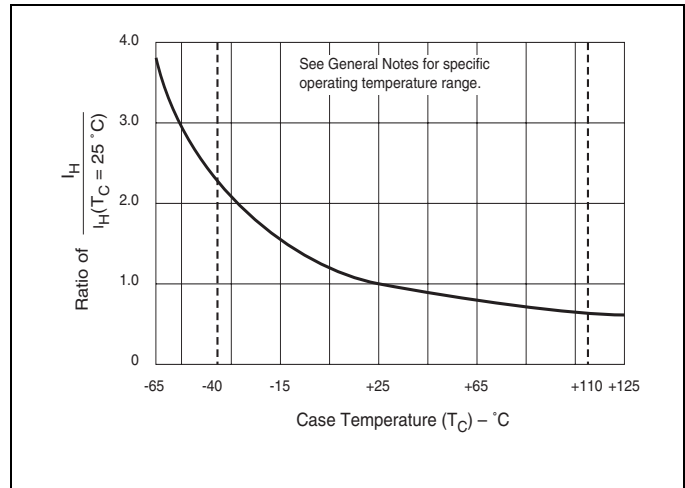

Figure E5.13 Normalized DC Holding Current versus Case Temperature

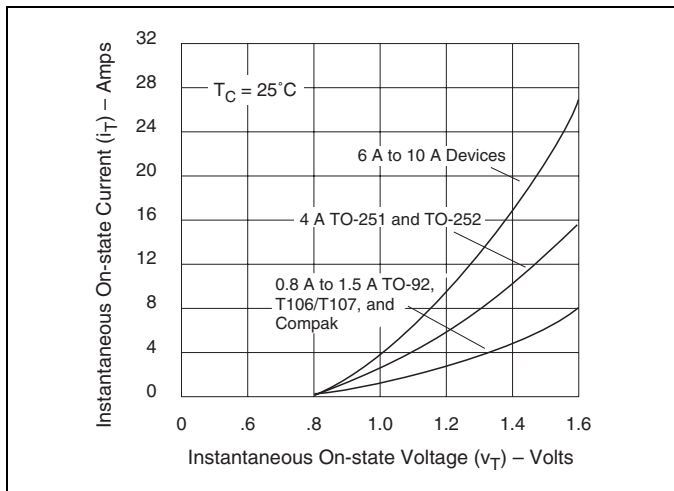

Figure E5.11 Instantaneous On-state Current versus On-state Voltage (Typical)

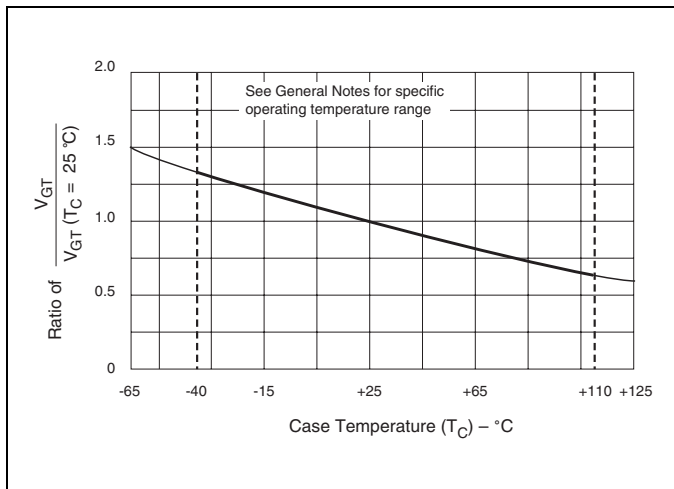

Figure E5.12 Normalized DC Gate-Trigger Voltage versus Case Temperature

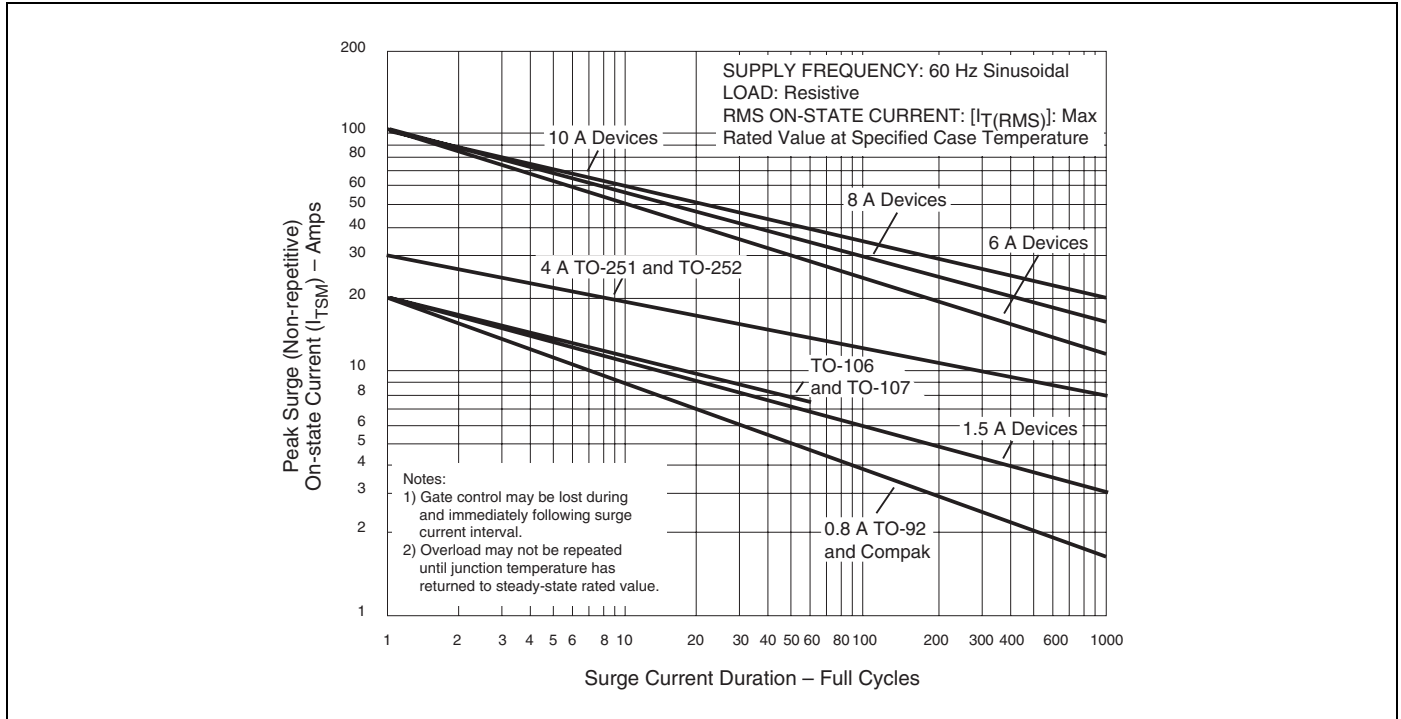

Figure E5.14 Peak Surge On-state Current versus Surge Current Duration

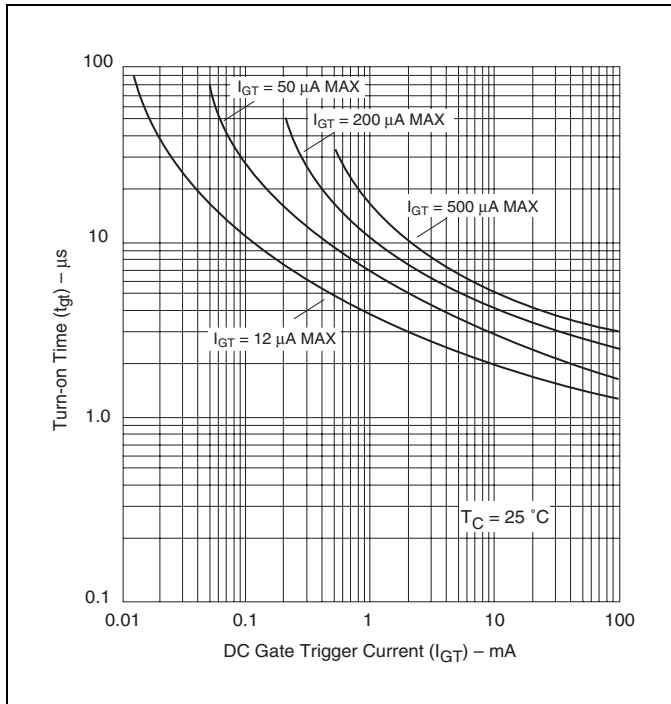

Figure E5.15 Typical Turn-on Time versus Gate Trigger Current

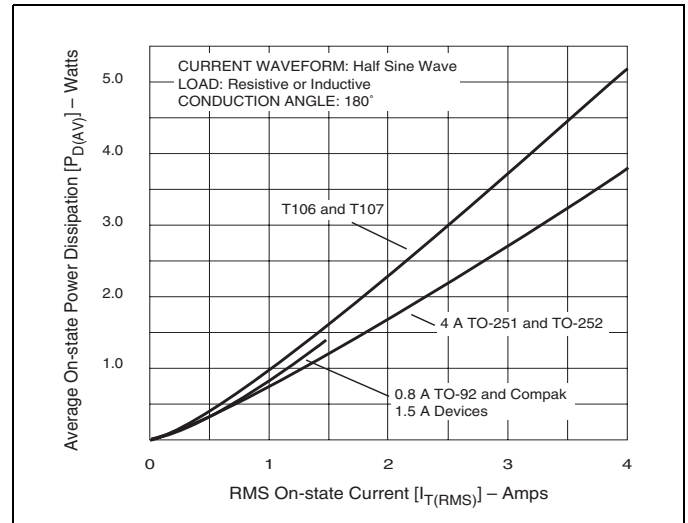

Figure E5.16 Power Dissipation (Typical) versus RMS On-state Current

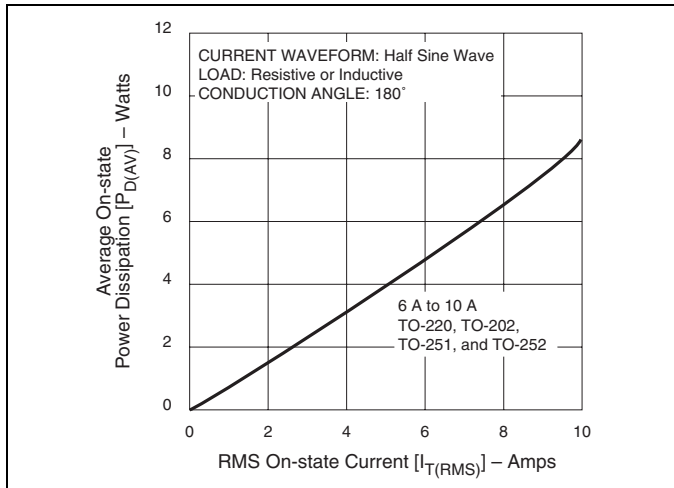

Figure E5.17 Power Dissipation (Typical) versus RMS On-state Current

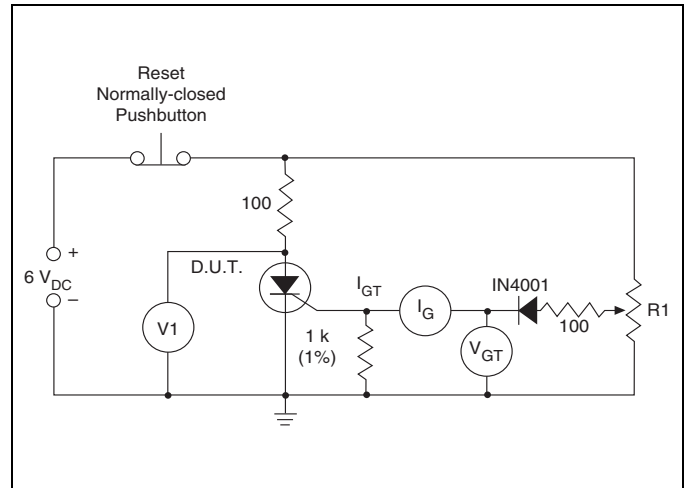

Figure E5.19 Simple Test Circuit for Gate Trigger Voltage and Current Measurement

- Note: V1 — 0 V to 10 V dc meter
- V_{GT} — 0 V to 1 V dc meter
- I_G — 0 mA to 1 mA dc milliammeter
- R1 — 1 k potentiometer

To measure gate trigger voltage and current, raise gate voltage (V_{GT}) until meter reading V1 drops from 6 V to 1 V. Gate trigger voltage is the reading on V_{GT} just prior to V1 dropping. Gate trigger current I_{GT} can be computed from the relationship

$$I_{GT} = I_G - \frac{V_{GT}}{1000} \text{ Amps}$$

where I_G is reading (in amperes) on meter just prior to V1 dropping.

Note: I_{GT} may turn out to be a negative quantity (trigger current flows out from gate lead).

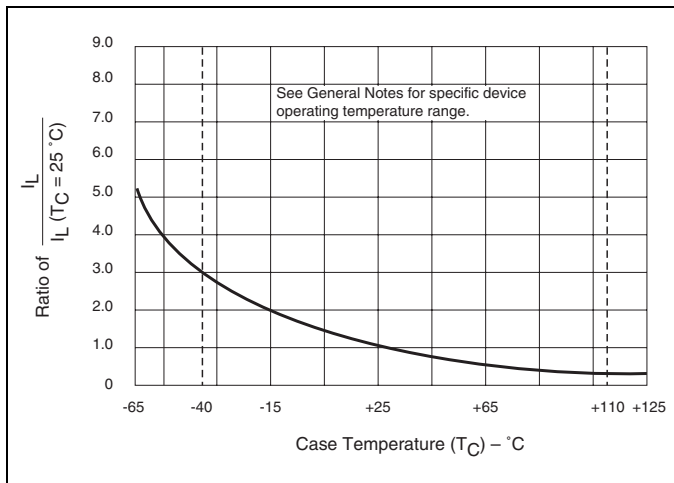

Figure E5.18 Normalized DC Latching Current versus Case Temperature

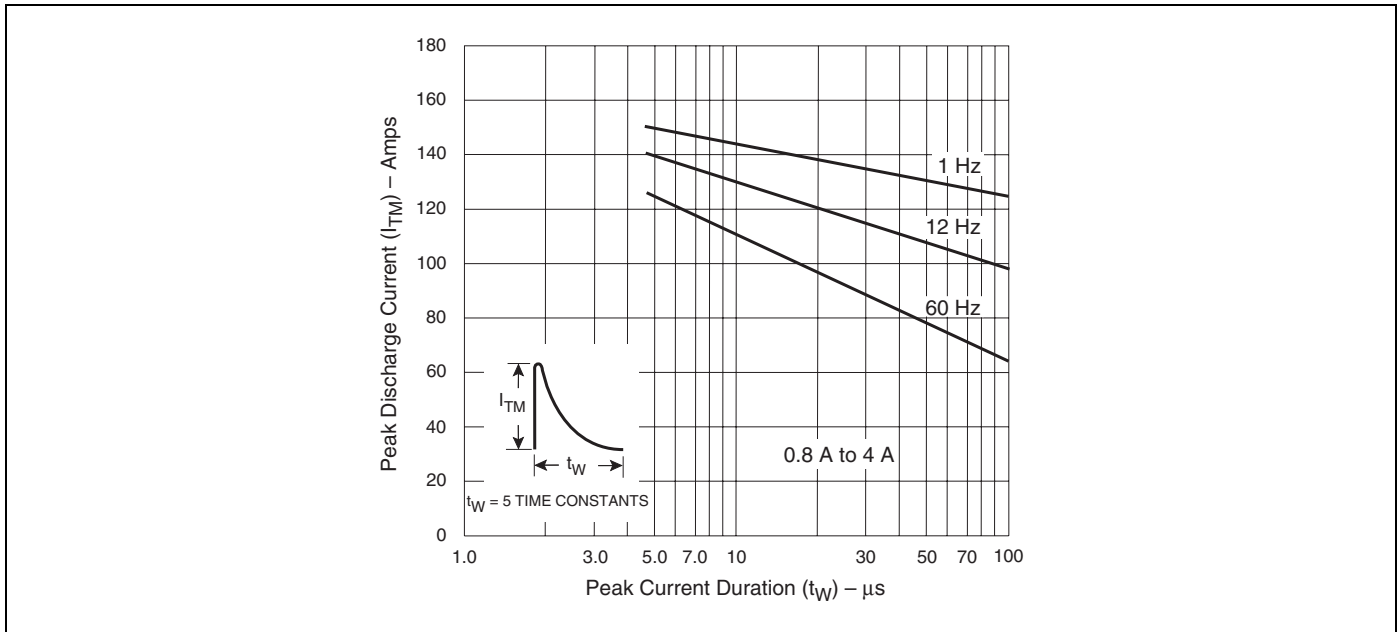

Figure E5.20 Peak Repetitive Capacitor Discharge Current

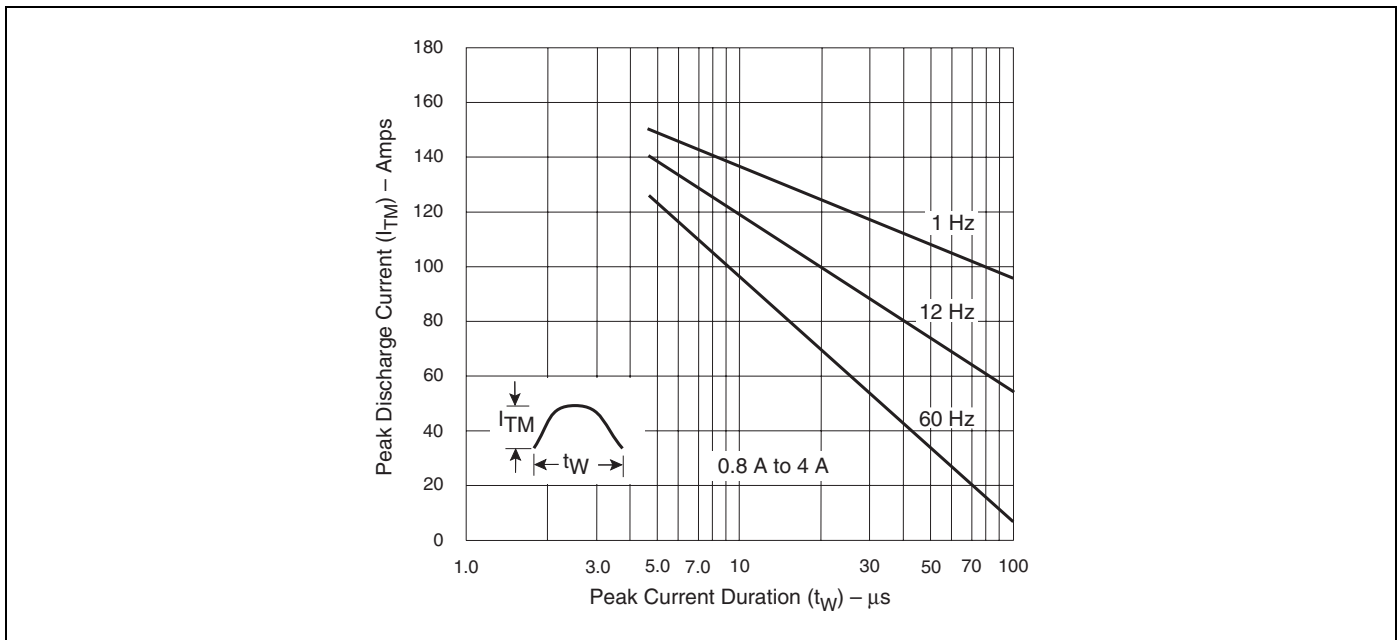

Figure E5.21 Peak Repetitive Sinusoidal Curve

